

STOLL



STOLL
ProfilLine FZ 43-34
ISOBUSConnected



PRICE LIST 2025

Valid from
15.01.2025



GENERAL NOTES ON FRONT LOADER PRODUCTS

„Front loaders without lowering protection do not meet the requirements of DIN EN 12525 in regard to the presence of persons in the danger area of the loader with raised load.“

„Front loaders without lowering choke do not meet the requirements for transport of persons; transport of persons requires the EU Typee testing according to the machinery directive 2006/42/EC.“

„Please make sure to observe the correct allocation of the lifting arm to the mounting kit installed on the tractor. Information in the installation instructions for the mounting kit in the chapter "List of tractors and usable front loaders".

„Wilhelm Stoll Maschinenfabrik GmbH does not know and has no access to the respective current manufacturer's specifications. In the event of possible restrictions on the part of the tractor manufacturer regarding the front loader attachment and its use, e.g. road approval, warranty or others, the end customer must be informed of this in advance in writing. Any claims arising from non-compliance with the aforementioned duty to provide information and from non-compliance with the manufacturer's specifications are excluded.“

CONTENTS.

Price overview – ProfiLine ISOBUSConnected, ProfiLine, Solid, CompactLine	6 - 8
Accessories – ProfiLine ISOBUSConnected, ProfiLine, Solid, CompactLine	9
Package prices	10 - 12
ProfiLine ISOBUSConnected, ProfiLine, Solid – Hydraulic controls and accessories	13 - 14
Hydro-Fix – Rapid hydraulic connection	15 - 16
Work quickly, safely and comfortably – with STOLL accessories	17 - 18
Color Edition	20
ProfiLine ISOBUSConnected	21
ProfiLine	22
Solid – The all-rounder	23
CompactLine – Smart power package	24
Tools	25 - 45
Recommended tool width	46 - 47
Your contacts at STOLL	48 - 49
General	51

With the publication of this price list all previous price lists are rendered invalid.



STOLL PRODUCT LINES.



**PROFILINE
ISOBUSCONNECTED**



PROFILINE



SOLID



COMPACTLINE

APPLICATION AREAS. SUITABLE FOR ALL REQUIREMENTS.





HOME OF QUALITY.

PRICE OVERVIEW.

The new era of front loaders is here. STOLL ProfiLine ISOBUSConnected ensures maximum integration of the loader into your tractor.

PROFILINE ISOBUSCONNECTED FZ

mechanic parallel linkage	Fixtures	FZ IB+ 39-23	FZ IB+ 39-27	FZ IB+ 39-31	FZ IB+ 41-25	FZ IB+ 41-29	FZ IB+ 41-33	FZ IB+ 43-27	FZ IB+ 43-30	FZ IB+ 43-34	FZ IB+ 46-26	FZ IB+ 46-29	FZ IB+ 46-33	FZ IB+ 48-33	FZ IB+ 48-37	FZ IB+ 48-42
		11.390 €	11.690 €	11.890 €	12.190 €	12.490 €	12.790 €	13.290 €	13.490 €	13.690 €	14.790 €	15.090 €	15.290 €	16.790 €	17.090 €	17.390 €
A	2.165 €	13.555 €	13.855 €	14.055 €	14.355 €	14.655 €	14.955 €	15.455 €	15.655 €	15.855 €	16.955 €	17.255 €	17.455 €	18.955 €	19.255 €	19.555 €
B	2.525 €	13.915 €	14.215 €	14.415 €	14.715 €	15.015 €	15.315 €	15.815 €	16.015 €	16.215 €	17.315 €	17.615 €	17.815 €	19.315 €	19.615 €	19.915 €
C	2.925 €	14.315 €	14.615 €	14.815 €	15.115 €	15.415 €	15.715 €	16.215 €	16.415 €	16.615 €	17.715 €	18.015 €	18.215 €	19.715 €	20.015 €	20.315 €
D	3.545 €	14.935 €	15.235 €	15.435 €	15.735 €	16.035 €	16.335 €	16.835 €	17.035 €	17.235 €	18.335 €	18.635 €	18.835 €	20.335 €	20.635 €	20.935 €

PROFILINE ISOBUSCONNECTED FS

hydraulic parallel linkage	Fixtures	FS IB+ 39-35	FS IB+ 41-37	FS IB+ 43-38	FS IB+ 46-37
		11.260 €	12.090 €	12.690 €	14.360 €
A	2.165 €	13.425 €	14.255 €	14.855 €	16.525 €
B	2.525 €	13.785 €	14.615 €	15.215 €	16.885 €
C	2.925 €	14.185 €	15.015 €	15.615 €	17.285 €
D	3.545 €	14.805 €	15.635 €	16.235 €	17.905 €

OPTIONS

ISOBUS	Price (excl. VAT)
Hydro-Fix (complete)	680 €
3rd control circuit or 4th control circuit	470 €
Hydro-Lock	740 €
Comfort-Drive electr. switched on/off	980 €
Real ³ function	1.345 €
Mechanical indicator for implement position	240 €

PROFILINE FZ

mech. parallel linkage	Fixtures	FZ 36-20	FZ 36-24	FZ 39-23	FZ 39-27	FZ 39-31	FZ 41-25	FZ 41-29	FZ 41-33	FZ 43-27	FZ 43-30	FZ 43-34	FZ 46-26	FZ 46-29	FZ 46-33	FZ 48-33	FZ 48-37	FZ 48-42
		7.190 €	7.390 €	7.590 €	7.890 €	8.090 €	8.390 €	8.690 €	8.990 €	9.490 €	9.690 €	9.890 €	10.990 €	11.290 €	11.490 €	12.990 €	13.290 €	13.590 €
A	2.165 €	9.355 €	9.555 €	9.755 €	10.055 €	10.255 €	10.555 €	10.855 €	11.155 €	11.655 €	11.855 €	12.055 €	13.155 €	13.455 €	13.655 €	15.155 €	15.455 €	15.755 €
B	2.525 €	9.715 €	9.915 €	10.115 €	10.415 €	10.615 €	10.915 €	11.215 €	11.515 €	12.015 €	12.215 €	12.415 €	13.515 €	13.815 €	14.015 €	15.515 €	15.815 €	16.115 €
C	2.925 €	10.115 €	10.315 €	10.515 €	10.815 €	11.015 €	11.315 €	11.615 €	11.915 €	12.415 €	12.615 €	12.815 €	13.915 €	14.215 €	14.415 €	15.915 €	16.215 €	16.515 €
D	3.545 €	10.735 €	10.935 €	11.135 €	11.435 €	11.635 €	11.935 €	12.235 €	12.535 €	13.035 €	13.235 €	13.435 €	14.535 €	14.835 €	15.035 €	16.535 €	16.835 €	17.135 €

PROFILINE FS

without parallel linkage	Fixtures	FS 36-24	FS 39-27	FS 39-31	FS 41-33	FS 43-34
		6.890 €	7.090 €	7.390 €	8.290 €	8.890 €
A	2.165 €	9.055 €	9.255 €	9.555 €	10.455 €	11.055 €
B	2.525 €	9.415 €	9.615 €	9.915 €	10.815 €	11.415 €
C	2.925 €	9.815 €	10.015 €	10.315 €	11.215 €	11.815 €
D	3.545 €	10.435 €	10.635 €	10.935 €	11.835 €	12.435 €

SOLID: Driven by the wishes of our customers, the engineers at STOLL have created a product that is both highly functional and flexible.

SOLID

P = parallel linkage H = without parallel linkage	Fixtures	28-14 P	30-16 P	35-18 P	38-20 P	40-22 P	30-16 H	35-18 H	38-20 H
		4.690 €	4.790 €	5.090 €	5.390 €	6.190 €	4.490 €	4.790 €	5.090 €
A	2.165 €	6.855 €	6.955 €	7.255 €	7.555 €	8.355 €	6.655 €	6.955 €	7.255 €
B	2.525 €	7.215 €	7.315 €	7.615 €	7.915 €	8.715 €	7.015 €	7.315 €	7.615 €
C	2.925 €	7.615 €	7.715 €	8.015 €	8.315 €	9.115 €	7.415 €	7.715 €	8.015 €
D	3.545 €	8.235 €	8.335 €	8.635 €	8.935 €	9.735 €	8.035 €	8.335 €	8.635 €

COMPACTLINE

mech. parallel linkage	Fixtures	150 P	250 P	350 P	450 P	550 P
		3.350 €	3.990 €	4.250 €	4.490 €	4.690 €
A	1.140 €	4.490 €	5.130 €	5.390 €	5.630 €	5.830 €
B	1.380 €	4.730 €	5.370 €	5.630 €	5.870 €	6.070 €
C	1.660 €	5.010 €	5.650 €	5.910 €	6.150 €	6.350 €
D	1.870 €	5.220 €	5.860 €	6.120 €	6.360 €	6.560 €

ACCESSORIES.

PROFILINE

PROFILINE FZ/FS	Price (excl. VAT)
Hydro-Fix cpl.	680 €
3rd control circuit or 4th control circuit	470 €
Tool-Fix cpl.	525 €
1/2 boom-end Tool-Fix	350 €
Comfort-Drive mech./ electr. switched on/off	610 € / 1.090 €
Hydro-Lock	740 €
RTL function (FZ only)	1.060 €
Real ³ function	1.345 €
Lowering safeguard **	905 €
** Additional equipment on both sides (kit)	460 €
Work lights (only FZ)	845 €

SOLID

SOLID	Price (excl. VAT)
Hydro-Fix cpl.	680 €
3rd control circuit or 4th control circuit*	405 €
Comfort-Drive	480 €
Lowering safeguard **	905 €
** Additional equipment on both sides (kit)	460 €

* 4th control circuit can only be ordered in combination with 3rd control circuit.

CONTROL CIRCUITS	Price (excl. VAT)
Base Control Universal	1.380 €
Base Control	1.685 €
Pro Control 3 key *	3.370 €
Pro Control 5 key *	3.525 €
Trac Control	345 €
Tubing set	400 €

* Pro Control must not be used in combination with front loaders without mechanical parallel linkage.

SPECIAL PAINT JOB FZ/FS/SOLID/FC	Price (NET excl. VAT)
Special colors	170 €
Special metallic or matt colors	1.200 €

More detailed information on page 20.

OPTIONAL EQUIPMENT (see tractor list)	Price (excl. VAT)
Rear axle support O-option	470 €

OPERATOR PROTECTIVE GUARD (OPG) KIT *	Price (NET excl. VAT)
With delivery / for reordering	390 €

* Suitable for tractors with ROPS in conjunction with STOLL front loaders from the CompactLine, Solid and ProLine series.

COMPACTLINE

COMPACTLINE	Price (excl. VAT)
Tool-Fix cpl.	565 €
Hydro-Fix cpl.	735 €
3rd control circuit	655 €
Comfort-Drive mech.	750 €
Lowering safeguard **	905 €
** Additional equipment on both sides (kit)	460 €

CONTROL CIRCUITS	Price (excl. VAT)
Base Control Direct	905 €
Base Control	1.545 €
Tubing set	435 €

FREIGHT

All prices are ex works plus individual freight costs, which you can find in the configurator on our website.

PACKAGE STANDARD.

ACCESSORIES PACKAGE: PROFILINE AND SOLID

incl. tubing set, 3rd control circuit, Comfort-Drive mech. + Hydro-Fix cpl.

PROFILINE FZ

Cat. Fixtures	Fixtures	FZ 36-20	FZ 36-24	FZ 39-23	FZ 39-27	FZ 39-31	FZ 41-25	FZ 41-29	FZ 41-33	FZ 43-27	FZ 43-30	FZ 43-34	FZ 46-26	FZ 46-29	FZ 46-33	FZ 48-33	FZ 48-37	FZ 48-42
A		11.515 €	11.715 €	11.915 €	12.215 €	12.415 €	12.715 €	13.015 €	13.315 €	13.815 €	14.015 €	14.215 €	15.315 €	15.615 €	15.815 €	17.315 €	17.615 €	17.915 €
B		11.875 €	12.075 €	12.275 €	12.575 €	12.775 €	13.075 €	13.375 €	13.675 €	14.175 €	14.375 €	14.575 €	15.675 €	15.975 €	16.175 €	17.675 €	17.975 €	18.275 €
C		12.275 €	12.475 €	12.675 €	12.975 €	13.175 €	13.475 €	13.775 €	14.075 €	14.575 €	14.775 €	14.975 €	16.075 €	16.375 €	16.575 €	18.075 €	18.375 €	18.675 €
D		12.895 €	13.095 €	13.295 €	13.595 €	13.795 €	14.095 €	14.395 €	14.695 €	15.195 €	15.395 €	15.595 €	16.695 €	16.995 €	17.195 €	18.695 €	18.995 €	19.295 €

PROFILINE FS

Cat. Fixtures	Fixtures	FS 36-24	FS 39-27	FS 39-31	FS 41-33	FS 43-34
A		11.215 €	11.415 €	11.715 €	12.615 €	13.215 €
B		11.575 €	11.775 €	12.075 €	12.975 €	13.575 €
C		11.975 €	12.175 €	12.475 €	13.375 €	13.975 €
D		12.595 €	12.795 €	13.095 €	13.995 €	14.595 €

SOLID

Cat. Fixtures	Fixtures	28-14 P	30-16 P	35-18 P	38-20 P	40-22 P	30-16 H	35-18 H	38-20 H
A		8.820 €	8.920 €	9.220 €	9.520 €	10.320 €	8.620 €	8.920 €	9.220 €
B		9.180 €	9.280 €	9.580 €	9.880 €	10.680 €	8.980 €	9.280 €	9.580 €
C		9.580 €	9.680 €	9.980 €	10.280 €	11.080 €	9.380 €	9.680 €	9.980 €
D		10.200 €	10.300 €	10.600 €	10.900 €	11.700 €	10.000 €	10.300 €	10.600 €

PACKAGE BASIC.

ACCESSORIES PACKAGE: PROFILINE AND SOLID

incl. Base Control, 3rd control circuit, Comfort-Drive mech. + Hydro-Fix cpl.

PROFILINE FZ

Cat. Fixtures	Fixtures	FZ 36-20	FZ 36-24	FZ 39-23	FZ 39-27	FZ 39-31	FZ 41-25	FZ 41-29	FZ 41-33	FZ 43-27	FZ 43-30	FZ 43-34	FZ 46-26	FZ 46-29	FZ 46-33	FZ 48-33	FZ 48-37	FZ 48-42
A		12.800 €	13.000 €	13.200 €	13.500 €	13.700 €	14.000 €	14.300 €	14.600 €	15.100 €	15.300 €	15.500 €	16.600 €	16.900 €	17.100 €	18.600 €	18.900 €	19.200 €
B		13.160 €	13.360 €	13.560 €	13.860 €	14.060 €	14.360 €	14.660 €	14.960 €	15.460 €	15.660 €	15.860 €	16.960 €	17.260 €	17.460 €	18.960 €	19.260 €	19.560 €
C		13.560 €	13.760 €	13.960 €	14.260 €	14.460 €	14.760 €	15.060 €	15.360 €	15.860 €	16.060 €	16.260 €	17.360 €	17.660 €	17.860 €	19.360 €	19.660 €	19.960 €
D		14.180 €	14.380 €	14.580 €	14.880 €	15.080 €	15.380 €	15.680 €	15.980 €	16.480 €	16.680 €	16.880 €	17.980 €	18.280 €	18.480 €	19.980 €	20.280 €	20.580 €

PROFILINE FS

Cat. Fixtures	Fixtures	FS 36-24	FS 39-27	FS 39-31	FS 41-33	FS 43-34
A		12.500 €	12.700 €	13.000 €	13.900 €	14.500 €
B		12.860 €	13.060 €	13.360 €	14.260 €	14.860 €
C		13.260 €	13.460 €	13.760 €	14.660 €	15.260 €
D		13.880 €	14.080 €	14.380 €	15.280 €	15.880 €

SOLID

Cat. Fixtures	Fixtures	28-14 P	30-16 P	35-18 P	38-20 P	40-22 P	30-16 H	35-18 H	38-20 H
A		10.105 €	10.205 €	10.505 €	10.805 €	11.605 €	9.905 €	10.205 €	10.505 €
B		10.465 €	10.565 €	10.865 €	11.165 €	11.965 €	10.265 €	10.565 €	10.865 €
C		10.865 €	10.965 €	11.265 €	11.565 €	12.365 €	10.665 €	10.965 €	11.265 €
D		11.485 €	11.585 €	11.885 €	12.185 €	12.985 €	11.285 €	11.585 €	11.885 €

PACKAGE PRO.

ACCESSORIES PACKAGE: PROFILINE AND SOLID

incl. Pro Control, 3rd control circuit, Comfort-Drive mech. + Hydro-Fix cpl.

PROFILINE FZ

Cat. Fixtures	Fixtures	FZ 36-20	FZ 36-24	FZ 39-23	FZ 39-27	FZ 39-31	FZ 41-25	FZ 41-29	FZ 41-33	FZ 43-27	FZ 43-30	FZ 43-34	FZ 46-26	FZ 46-29	FZ 46-33	FZ 48-33	FZ 48-37	FZ 48-42
A		14.485 €	14.685 €	14.885 €	15.185 €	15.385 €	15.685 €	15.985 €	16.285 €	16.785 €	16.985 €	17.185 €	18.285 €	18.585 €	18.785 €	20.285 €	20.585 €	20.885 €
B		14.845 €	15.045 €	15.245 €	15.545 €	15.745 €	16.045 €	16.345 €	16.645 €	17.145 €	17.345 €	17.545 €	18.645 €	18.945 €	19.145 €	20.645 €	20.945 €	21.245 €
C		15.245 €	15.445 €	15.645 €	15.945 €	16.145 €	16.445 €	16.745 €	17.045 €	17.545 €	17.745 €	17.945 €	19.045 €	19.345 €	19.545 €	21.045 €	21.345 €	21.645 €
D		15.865 €	16.065 €	16.265 €	16.565 €	16.765 €	17.065 €	17.365 €	17.665 €	18.165 €	18.365 €	18.565 €	19.665 €	19.965 €	20.165 €	21.665 €	21.965 €	22.265 €

PROFILINE FS

Cat. Fixtures	Fixtures	FS 36-24	FS 39-27	FS 39-31	FS 41-33	FS 43-34
A		14.185 €	14.385 €	14.685 €	15.585 €	16.185 €
B		14.545 €	14.745 €	15.045 €	15.945 €	16.545 €
C		14.945 €	15.145 €	15.445 €	16.345 €	16.945 €
D		15.565 €	15.765 €	16.065 €	16.965 €	17.565 €



SOLID

Cat. Fixtures	Fixtures	28-14 P	30-16 P	35-18 P	38-20 P	40-22 P	30-16 H	35-18 H	38-20 H
A		11.790 €	11.890 €	12.190 €	12.490 €	13.290 €	11.590 €	11.890 €	12.190 €
B		12.150 €	12.250 €	12.550 €	12.850 €	13.650 €	11.950 €	12.250 €	12.550 €
C		12.550 €	12.650 €	12.950 €	13.250 €	14.050 €	12.350 €	12.650 €	12.950 €
D		13.170 €	13.270 €	13.570 €	13.870 €	14.670 €	12.970 €	13.270 €	13.570 €

PROFILINE. SOLID. HYDRAULIC CONTROL AND ACCESSORIES.

HIGH COMFORT AND EASY OPERATION WITH HYDRAULIC CONTROLS.

BASE CONTROL			Price (excl. VAT)
	<ul style="list-style-type: none"> ✓ High operating comfort with safe, exact loader guidance. ✓ Integrated push-button switch for additional functions. ✓ Five basic functions: lift, lower, scoop, dump, float position. ✓ Locking function for road driving. 	Base Control (adapted)	1.685 €
		Assembly kit (universal) (without hydraulic tubing and cab mount)	1.380 €
PRO CONTROL			Price (excl. VAT)
	<ul style="list-style-type: none"> ✓ Simple, proportional loader operation. ✓ Six basic functions: lift, lower, scoop, dump, float position, float position for tools. ✓ Three additional functions: rapid emptying, 3rd/4th control circuit, locking function for road driving. ✓ Additionally possible: Hydro-Lock, Comfort-Drive and tractor functions (load control). 	Pro Control (ECO-Pro system for OC, OCLS, CCLS)	3.370 €
		5-button joystick optional (additional cost)	155 €
ISOBUS JOYSTICK			Price (excl. VAT)
	<ul style="list-style-type: none"> ✓ Optimum control of all functions 	Only necessary if the tractor's own joystick is not fully integrated into the ISOBUS (no buttons and axes can be assigned)	1.180 €
		The joystick can also be used for other ISOBUS participants.	

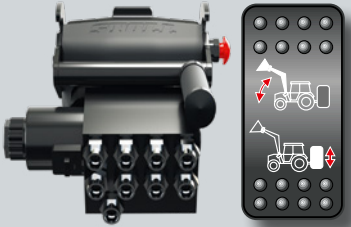
DOUBLE LOCKING		Price (excl. VAT)
	<ul style="list-style-type: none"> ✓ Standard for size 5 + 6 (see p. 18). ✓ Optional for size 4 (see p. 18). ✓ For heavy work loads. 	560 €
TRAC CONTROL		Price (excl. VAT)
	<ul style="list-style-type: none"> ✓ Five basic functions: lift, lower, scoop, dump, float position. ✓ The ergonomic Trac Control replaces the original push-button-less tractor joystick for electronic functions. 	350 €
TUBING SET HYDRAULICS		Price (excl. VAT)
	<ul style="list-style-type: none"> ✓ Used when tractor has own control devices available. ✓ Individual adaptation to the tractor in question. ⚠ A double function and/or an external actuation must be rendered impossible by a correct installation. 	400 €
COMFORT-HYDRAULICS		Price (excl. VAT)
	<ul style="list-style-type: none"> ✓ Pre-selector switch to activate front loader or rear hydraulics. ✓ Prevents any possible double activation of front loader and rear hydraulics. ⚠ The possibility of the system being activated externally must be eliminated by a correct installation. 	1.090 €

The single-lever control devices on offer are exclusively intended for use with agricultural or forestry tractors for operation of STOLL front loaders.

HYDRO-FIX. RAPID HYDRAULIC CONNECTION.





ALL HYDRAULIC LINES ARE RAPIDLY CONNECTED
AND RELEASED – WITH JUST ONE HANDLE.

STOLL ISOBUS HYDRO-FIX / 3x COUPLING *		Type	Order No.	Price (excl. VAT)
	Hydro-Fix cpl.	FZ IB+/FS IB+	3811820	680 €
	Plug plate (above)	FZ IB+/FS IB+	3812320	285 €
	Equip. Second tractor / Socket Plate (below)	FZ IB+/FS IB+	3812330	395 €
	* able to couple under high pressure			



STOLL HYDRO-FIX – RECTANGULAR / 4X COUPLING *		Type	Order No.	Price (excl. VAT)
	Hydro-Fix cpl. Stoll SLC	FZ/FS	3645170	680 €
	Hydro-Fix cpl. w/o Stoll SLC	FZ/FS	3645180	680 €
	Plug plate (above)	FZ/FS	3645190	285 €
	Equip. second tractor Stoll SLC	FZ/FS	3609870	395 €
	Equip. second tractor w/o Stoll SLC	FZ/FS	3609860	395 €
	* able to couple under high pressure			

STOLL HYDRO-FIX – RECTANGULAR / 4X COUPLING *		Type	Order No.	Price (excl. VAT)
	Hydro-Fix cpl.	FZ/FS/S	3645300	680 €
	Plug plate (above)	FZ/FS/S	3645190	285 €
	Equip. Second tractor	FZ/FS/S	3537370	395 €
	* able to couple under high pressure			



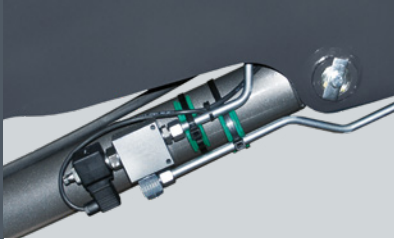
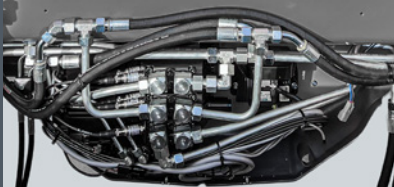

STOLL HYDRO-FIX – RECTANGULAR W. ELECTRIC 8-PIN PLUG *		Type	Order No.	Price (excl. VAT)
	Hydro-Fix cpl. Stoll SLC	FZ/FS/S	3645200	865 €
	Hydro-Fix cpl. w/o Stoll SLC	FZ/FS/S	3645220	865 €
	Plug plate (above)	FZ/FS/S	3645230	470 €
	Equip. for second tractor Stoll SLC	FZ/FS/S	3618680	395 €
	Equip. for second tractor w/o Stoll SLC	FZ/FS/S	3618690	395 €
	* able to couple under high pressure			

STOLL HYDRO-FIX – 6X COUPLING / DOES NOT CONNECT TO SLC		Type	Order No.	Price (excl. VAT)
	Hydro-Fix cpl.	FZ/FS	3614720	935 €
	Plug plate (above)	FZ/FS	3618670	350 €
	Equip. for second tractor	FZ/FS	3617840	585 €
MULTI-COUPLER – FOR SPECIAL FENDT TRACTORS / VARIO *				
	Multi-Coupler cpl.	FZ/FS/S	3645240	805 €
	Plug plate (above)	FZ/FS/S	3645260	320 €
	Socket plate (below)	FZ/FS/S	3537390	485 €
* able to couple under high pressure				
MULTI-COUPLER – CARGO *				
	Multi-Coupler cpl. with integrated electrical plug	FZ/FS/S	3645250	805 €
	Plug plate (above)	FZ/FS/S	3645270	320 €
	Socket plate (below)	FZ/FS/S	3537400	485 €
* able to couple under high pressure				
STOLL TOOL-FIX – 2X COUPLING / FOR 3RD + 4TH CONTROL CIRCUITS				
	Tool-Fix cpl.	FZ/FS	3331530	525 €
	Half boom end	FZ/FS	3474580	350 €
	Half attachment end	FZ/FS	3617080	175 €

WORK QUICKLY, SAFELY AND COMFORTABLY. WITH STOLL ACCESSORIES.

3RD/4TH CONTROL CIRCUIT		Price (excl. VAT)
	<ul style="list-style-type: none"> ✔ Simple operation of hydraulic tools. ✔ No further special control device is needed. ✔ e.g. for silage forks, bale grabs or bale forks. 	Solid: simultaneous delivery 3rd control circuit 405 €
		ProfiLine: simultaneous / subsequent delivery (individual price) 470 €
		Additional price for Tool-Fix (only FZ / FS, individual price) 525 €
HYDRO-LOCK		Price (excl. VAT)
	<ul style="list-style-type: none"> ✔ Functioning via double-acting hydraulic cylinder. ✔ Button-activated insertion and extraction of locking bolt. ✔ Attachment change without dismounting. 	Hydro-Lock FZ / FS 740 €
LOWERING SAFEGUARD		Price (excl. VAT)
	<ul style="list-style-type: none"> ✔ Sudden dropping of the loader is prevented. ✔ Required for Work with a raised front loader that requires the presence of persons in the working area of the front loader. ✔ Fulfills the requirements of EN 12525/A1. ⚠ Does not meet the legal requirements with regard to work baskets. 	For ProfiLine FZ / FS sizes 1 - 6 (see p.18), all Solid and CompactLine models. (assembly kit, individual price) 905 €
		Additional equipment for both sides (assembly kit) 460 €
REAL ³ ISOBUSConnected		Price (excl. VAT)
	<ul style="list-style-type: none"> ✔ With our ISOBUSConnected, the lift arm and the separate 3rd control circuit can be operated via the tractor's own terminal using the existing joystick (continuous run). 	1.345 €

The Comfort-Drive accessory function reduces impacts from loader and attachment – result: man and machine are treated with care. Thanks to technology!

LOWERING RESTRICTOR		Price (excl. VAT)
	<ul style="list-style-type: none"> ✓ Built in throttle valves limit the lowering speed of the front loader. ✓ Stop-cocks on the attachment cylinders prevent pivoting motion (not included in assembly kit). ✓ Required with the deployment of working platforms. ⚠ For the transport of persons, an EC-type examination as defined by the EU directive on machinery (2006/42/EC) is mandatory. 	For ProfiLine FZ / FS sizes 1 - 6 (see p.18) (assembly kit, individual price) 400 €
	Recommended both sides	
COMFORT-DRIVE		Price (excl. VAT)
	<ul style="list-style-type: none"> ✓ To smooth out the drive with an attached front loader. ✓ Hard impacts from uneven ground are cushioned. ✓ Driver and tractor are protected. 	1 Comfort-Drive FZ / FS 610 €
		Additional cost for electrically (de)activated Comfort-Drive FZ / FS 480 €
		2 Comfort-Drive Solid 480 €
RETURN TO LEVEL		Price (excl. VAT)
	<ul style="list-style-type: none"> ✓ Time savings and high loading performance through levelling automation. ✓ An attachment position, once set, can be replicated with the touch of a button. ✓ Operational with all Stoll single-lever control systems – no extra device needed. ✓ Additional rapid emptying function included. 	For ProfiLine FZ 1.060 €
ISOBUSCONNECTED DISPLAY		Price (excl. VAT)
	<ul style="list-style-type: none"> ✓ Optimum control of all functions. 	Necessary if no original tractor display is available. Price on request

REAL ³		Price (excl. VAT)
	<ul style="list-style-type: none"> ✓ Third control circuit to control the attachments independently of the front loader controls. ✓ The attachment is directly fed from the tractor's hydraulic pump. ✓ Optimal use of attachments through simultaneous performance of their functions. 	Lifting arm cable set equipment 760 €
		Real3 rd Bowden cable valve 1.345 €
		Real3 rd electrohydraulics valve 1.345 €
		Real3 rd valve (retrofit in connection with tractor-own valves) 775 €
		2 Hydro-Fix + Retrofitting 350 €
		4 Hydro-Fix 680 €
		6 Hydro-Fix (only in connection with the tubing set) 925 €
SWITCH BOX		Price (excl. VAT)
	<ul style="list-style-type: none"> ✓ Contains all switches for operation of the electrical functions of the front loader. ✓ Reduction of work time and assembly costs – all connections in one place. ✓ Available for all ProfilLine front loaders. 	For ProfilLine FZ / FS (assembly kit) 210 €
CAMERA SYSTEM AND WORK LIGHTS		Price (excl. VAT)
	<ul style="list-style-type: none"> ✓ For goal-oriented and exact work – the camera system and the work lights helps the driver see better. ✓ High comfort and improved efficiency when working with the attachment. 	Camera system consisting of monitor, camera and cable set (incl. suction cup and holder) 910 €
		Camera (individual price) 350 €
		Monitor (individual price) 555 €
		Work lights (only FZ) 845 €
WEAR SKIDS		Price (excl. VAT)
	<ul style="list-style-type: none"> ✓ The loader is protected in this area from wear caused by rough terrain. ✓ Can be retrofitted at any time thanks to protected screw connection. 	Wear skid 120 €
		ProfilLine FZ 46 Series
		ProfilLine FZ 48 Series

COLOR EDITION. SPECIAL PAINTING.

CUSTOM COLORS.

More colours possible. Surcharge 170€ net plus VAT.



FENDT
GREEN



FENDT
NATURE GREEN



JOHN DEERE
GREEN



DEUTZ
YELLOW-GREEN
RAL 6018



KUBOTA
ORANGE



KOMMUNAL
ORANGE
RAL 2011



MASSEY
FERGUSON
RED



CASE
RED



SAME
RED



MCCORMICK
RED



LANDINI
BLUE



NEW HOLLAND
BLUE



LANDINI
BLACK



BLACK
RAL 9005



STEYR
WHITE
RAL 9018



SIGNAL WHITE
RAL 9003



TRAFFIC WHITE
RAL 9016



LAMBORGHINI
WHITE
RAL 9003

STOLL STANDARD COLOR.

No extra charge.



BLACK GREY
RAL 7021

SPECIAL COLORS.

Now also available in special colors such as metallic or matt.
Surcharge 1.200€ net plus VAT.



DEUTZ
JAVA GREEN



MCCORMICK
METALLIC RED



LANDINI
METALLIC BLUE



NEW HOLLAND
BLUE POWER

Adapt the front loader to your tractor.
Or simply make it your own.

The new era of front loaders is here. **STOLL ProfiLine ISOBUSConnected** ensures maximum integration of the loader into your tractor.

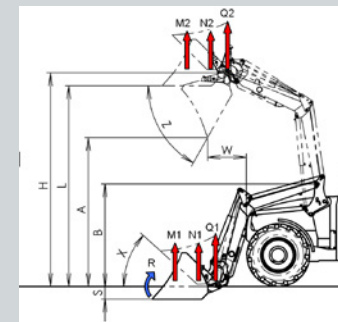

Attention!
An OPG must be used for tractors with ROP (without cab). The front loader must not be used without an OPG! See page 9.

PROFILINE ISOBUSCONNECTED

PROFILINE ISOBUSCONNECTED				SIZE 2				SIZE 3				SIZE 4				SIZE 5				SIZE 6						
FZ (mechanical self-leveling)				FZ IB+ 39-23	FZ IB+ 39-27	FZ IB+ 39-31		FZ IB+ 41-25	FZ IB+ 41-29	FZ IB+ 41-33		FZ IB+ 43-27	FZ IB+ 43-30	FZ IB+ 43-34		FZ IB+ 46-26	FZ IB+ 46-29	FZ IB+ 46-33		FZ IB+ 48-33	FZ IB+ 48-37	FZ IB+ 48-42				
FS (hydraulic self-leveling)							FS IB+ 39-35				FS IB+ 41-37				FS IB+ 43-38				FS IB+ 46-37							
Suitable for tractors with kW/hp			kW hp	45-95 60-130	60-95 80-130	65-95 90-130		60-120 80-160	75-120 100-160	80-120 110-160		75-130 100-180	85-130 110-180	95-130 130-180		95-190 130-260	105-190 140-260	120-190 160-260		140-220 190-300	150-220 200-300	155-220 210-300				
Lifting force approx. in the implement's pivot point	below 1,5m above	Q1 W Q2	daN daN daN	2300 1850 1550	2670 2140 1800	3070 2460 2060	3490 2800 2360	2510 2040 1680	2880 2340 1930	3280 2660 2200	3710 3010 2490	2660 2230 1890	3060 2530 2120	3420 2860 2430	3830 3210 2760	2580 2280 2020	2940 2600 2280	3320 2930 2590	3720 3290 3000	3320 2760 2230	3730 3100 2500	4150 3450 2790				
Lifting force (blade) approx. 300 mm before the pivot point	below 1,5m above	N1 N2	daN daN daN	2300 1850 1550	2670 2140 1800	3070 2460 2060	3000 2510 1970	2510 2040 1680	2880 2340 1930	3280 2660 2200	3210 2700 2110	2660 2230 1890	3060 2530 2120	3420 2860 2430	3360 2900 2330	2580 2280 2020	2940 2600 2280	3320 2930 2590	3290 2990 2565	3320 2760 2230	3730 3100 2500	4150 3450 2790				
Lifting force (pallet) approx. 800 mm before the pivot point	below 1,5m above	M1 M2	daN daN daN	2300 1850 1550	2670 2140 1800	3070 2460 2060	2430 2130 1545	2510 2040 1680	2880 2340 1930	3280 2660 2200	2620 2320 1680	2660 2230 1890	3060 2530 2120	3420 2860 2430	2785 2500 1840	2580 2280 2020	2940 2600 2280	3320 2930 2590	2750 2600 2060	3320 2760 2230	3730 3100 2500	4150 3450 2790				
Breakout force 800 mm before the pivot point	below	R	daN	2910	3550	3550	3080	2900	3540	3850		3540	4580		3840	4560		4140	4900							
800 mm lift height in the implement's pivot		H	mm	3850				4100				4320				4550				4800						
Overloading height (H-210)		L	mm	3640				3890				4110				4340				4590						
Dump height		A	mm	2810				3060				3290				3490				3750						
Dump width		W	mm	700				790				780				800				880						
Digging depth		S	mm	210				210				210				210				210						
Pivot point of lifting arms		B	mm	1800				1945				1945				2045				2180						
Tilt angle	below	X	° degree	44°				44°				44°				44°				45°						
	rescoped	X1	° degree	61°				-				61°				-				63°				-		
Dumping angle	above	Z	° degree	57°				57°				56°				58°				58°						
Pump output rate			l/min	75				90				90				100				120						
Lifting cylinder			mm	Ø 65 mm	Ø 70 mm	Ø 75 mm	Ø 80 mm	Ø 70 mm	Ø 75 mm	Ø 80 mm	Ø 85 mm	Ø 75 mm	Ø 80 mm	Ø 85 mm	Ø 90 mm	Ø 75 mm	Ø 80 mm	Ø 85 mm	Ø 90 mm	Ø 85 mm	Ø 90 mm	Ø 95 mm				
Stroke time			sec.	3,4	3,9	4,5	5,1	3,3	3,8	4,3	4,8	3,8	4,3	4,8	5,4	3,6	4,3	4,7	5,3	3,8	4,2	4,7				
Tilting time, implement			sec.	0,6	0,7	0,7	0,6	0,5	0,6	0,6	0,6	0,6	0,7	0,7	0,7	0,6	0,7	0,7	0,6	0,5	0,6	0,6				
Dumping time, implement			sec.	1,3	1,6	1,6	2,2	1,1	1,3	1,4	2,1	1,3	1,7	1,7	2,3	1,3	1,6	1,6	2,1	1,2	1,4	1,4				
Weight, lifting arms without implement			kg	604	610	612	575	650	657	665	615	767	770	775	710	852	860	864	790	886	890	898				

Values given are average values, depending on tractor type and loader equipment, there may be deviations upwards or downwards.
The specified lifting forces are only applicable for the specified height of the swing pivot point B calculated for 195 bar hydraulic pressure.
Due to the risk of the tractor tipping over, front loader work is only permitted in conjunction with a suitable rear weight. Calculated with 195 bar hydraulic pressure!

Best performance in terms of lifting power and height. Top values in stability and loading speed. Comfortable to operate: the ProfiLine was specifically developed to fulfil all the needs of true professionals.

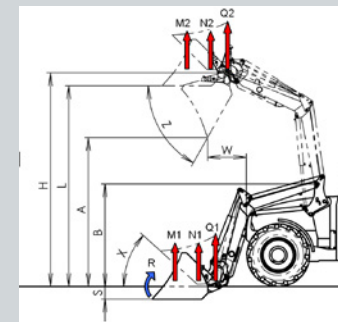

Attention!
An OPG must be used for tractors with ROP (without cab). The front loader must not be used without an OPG! See page 9.

PROFILINE

PROFILINE				SIZE 1			SIZE 2				SIZE 3				SIZE 4				SIZE 5			SIZE 6			
mech. parallel linkage				FZ 36-20	FZ 36-24		FZ 39-23	FZ 39-27		FZ 39-31		FZ 41-25	FZ 41-29	FZ 41-33		FZ 43-27	FZ 43-30	FZ 43-34		FZ 46-26	FZ 46-29	FZ 46-33	FZ 48-33	FZ 48-37	FZ 48-42
without parallel linkage						FS 36-24			FS 39-27					FS 41-33				FS 43-34							
Suitable for tractors with kW/hp			kW hp	40-75 50-100	50-75 70-100	45-95 60-130	60-95 80-130	65-95 90-130	60-120 80-160	75-120 100-160	80-120 110-160	75-130 100-180	85-130 110-180	95-130 130-180	95-190 130-260	105-190 140-260	120-190 160-260	140-220 190-300	150-220 200-300	155-220 210-300					
Lifting force in the implement's pivot point	below above	Q1 Q2	daN daN	2.020 1.490	2.370 1.750	2.300 1.550	2.670 1.800	3.070 2.060	2.510 1.680	2.880 1.930	3.280 2.200	2.660 1.890	3.060 2.120	3.420 2.430	2.580 2.020	2.940 2.280	3.320 2.590	3.320 2.230	3.730 2.500	4.150 2.790					
Lifting force (blade) 300 mm before the pivot point	below above	N1 N2	daN daN	2.020 1.490	2.370 1.750	2.020 1.470	2.300 1.550	2.670 1.800	2.300 1.500	3.070 2.060	2.640 1.730	2.510 1.680	2.880 1.930	3.280 2.200	2.840 1.870	2.660 1.890	3.060 2.120	3.420 2.430	3.0 2.080	2.580 2.020	2.940 2.280	3.320 2.590	3.320 2.230	3.730 2.500	4.150 2.790
Lifting force (pallet) 800 mm before the pivot point	below above	M1 M2	daN daN	2.020 1.490	2.370 1.750	1.620 1.150	2.300 1.550	2.670 1.800	1.860 1.180	3.070 2.060	2.130 1.360	2.510 1.680	2.880 1.930	3.280 2.200	2.320 1.490	2.660 1.890	3.060 2.120	3.420 2.430	2.480 1.640	2.580 2.020	2.940 2.280	3.320 2.590	3.320 2.230	3.730 2.500	4.150 2.790
Breakout force 800 mm before the pivot point	below	R	daN	2.620	2.890	2.910	3.550	3.080	3.550	3.080	2.900	3.540	3.850	3.540	4.580	3.840	4.560	4.140	4.900						
Maximum lift height in the implement's pivot point		H	mm	3.550	3.850	4.100	4.320	4.550	4.800																
Overloading height (H-210)		L	mm	3.340	3.640	3.890	4.110	4.340	4.590																
Dump height		A	mm	2.470	2.810	3.060	3.290	3.490	3.750																
Dump width		W	mm	710	700	790	780	800	880																
Digging depth		S	mm	210	210	210	210	210	210																
Pivot point of lifting arms		B	mm	1.680	1.800	1.945	1.945	2.045	2.180																
Tilt angle	below	X	° degree	41°	44°	44°	44°	44°	45°																
	rescooped	X1	° degree	55°	-	61°	-	61°	-	61°	-	61°	-	61°	-	63°	-	63°	-	62°					
Dump angle	above	Z	° degree	62°	57°	57°	57°	57°	57°																
Pump output rate			l/min	60	75	90	100	120																	
Stroke time			sec.	3,9	4,2	3,4	3,9	4,5	3,3	3,8	4,3	3,8	4,3	4,8	3,6	4,3	4,7	3,8	4,2	4,7					
Tilting time, implement			sec.	0,5	0,7	0,6	0,7	0,6	0,7	0,6	0,5	0,6	0,6	0,6	0,6	0,7	0,7	0,7	0,6	0,7	0,7	0,5	0,6	0,6	0,6
Dumping time, implement			sec.	1,3	1,6	1,3	1,6	2,2	1,6	2,2	1,1	1,3	1,4	2,1	1,3	1,7	1,7	2,3	1,3	1,6	1,6	1,2	1,4	1,4	1,4
Weight, lifting arms without implement			kg	555	562	480	604	610	528	612	530	650	657	665	580	767	770	775	675	852	860	864	886	890	898

The values given are averages. Depending on the type of tractor, these values may deviate up or down.
Due to the risk of the tractor tipping over, front loader work is only permitted in conjunction with a suitable rear weight.
Calculated at 195 bar hydraulic pressure!

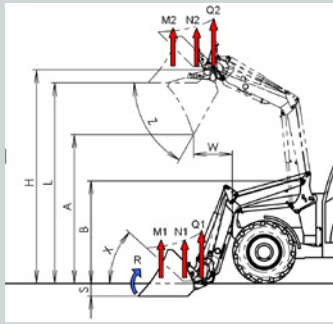

Attention!
An OPG must be used for tractors with ROP (without cab). The front loader must not be used without an OPG! See page 9.

Numbers become values. Our values for you are:
tradition, quality and innovation.

SOLID

SOLID			28-14	30-16		35-18		38-20		40-22	
TYPE			P	P	H	P	H	P	H	P	
Suitable for tractors with kW / horsepower		kW hp	29-44 40-60	35-50 45-65		40-60 55-80		50-80 65-100		60-100 80-135	
Lifting power l at attachment pivot point	lowered	Q1	1.400	1.560		1.810		1.960		2.100	
	raised	Q2	900	1.220		1.270		1.410		1.530	
Lifting power (bucket) 300mm in front of the pivot	lowered	N1	1.400	1.560	1.310	1.810	1.520	1.960	1.670	2.100	
	raised	N2	900	1.220	10	1.270	1.050	1.410	1.180	1.530	
Lifting power (fork) 900 mm in front of pivot	lowered	M1	1.400	1.560	990	1.810	1.160	1.960	1.300	2.100	
	raised	M2	900	1.220	740	1.270	780	1.410	890	1.530	
Breakout power 900 mm in front of pivot		R	1.370	1.870	1.590	2.310	1.570	2.360	2.120	2.600	
Max. Lift height at attachment pivot		H	mm	2.760	3.010		3.460		3.760		4.080
Loading height		L	mm	2.550	2.800		3.250		3.550		3.870
Dump height		A	mm	1.365	1.920		2.390		2.710		3.040
Dump clearance		W	mm	550	600		650		700		785
Digging depth		S	mm	210	210		210		210		210
Boom pivot		B	mm	1.399	1.400		1.660		1.780		1.930
Rollback angle	lowered	X	° degree	41	43		43		46		46
Dump angle raised	raised	Z	° degree	72	63		63		58		58
Pump performance			l/min.	50	50		50		50		60
Raising time			sec.	3	4		4		5		5
Rollback time, attachment	lowered		sec.	1,4	1,5		1,5		1,5		1,5
Dump time, attachment	raised		sec.	1,6	1,7		1,7		1,7		1,7
Weight, loader boom w/o attachment			kg	305	315	275	335	290	355	315	395

Values given are averages. Depending on tractor type, variations up and down will occur.
Because of danger of rolling the tractor, front loader work can only be carried out with a suitable counter weight.
Calculated with 195 bar hydraulic pressure!

- +** MECHANICAL PARALLEL LIFT
- +** SAME DRIVE-IN SYSTEM AS PROFILINE FRONT LOADERS
- +** OUTSTANDING TILT AND DUMP ANGLE
- +** LOW INHERENT WEIGHT
- +** IMPROVED PERFORMANCE DATA
- +** MODERN LOOK
- +** OPTIONAL: HYDRO-FIX UPPER PART, 3RD CONTROL CIRCUIT, 4TH CONTROL CIRCUIT AND COMFORT-DRIVE
- +** SPECIAL PAINT JOB (FOR AN EXTRA FEE)

MADE IN GERMANY

The FC 150, like its big brothers, has a Skid Steer frame for its attachment range. Flexibility and versatility are vital to us.

COMPACTLINE

FC COMPACTLINE				FC 150	FC 250	FC 350	FC 450	FC 550
TYPE				P+	P+	P+	P+	P+
Suitable for tractors with kW / horsepower			kW hp	11-18 15-25	15-26 20-35	18-37 25-50	26-40 35-55	29-44 40-60
Tractor weight			kg	700-1.000	800-1.300	1.100-1.600	1.500-2.000	1.800-2.300
Lifting power I at attachment pivot point	lowered raised	Q1 Q2	daN	435 350	640 * 540	950 * 790	970 * 920	1.170 * 1.120
Lifting power (bucket) 300mm in front of the pivot	lowered raised	N1 N2	daN	390 310	570 480	850 710	870 820	1.050 1.010
Lifting power (fork) 700mm in front of pivot	lowered raised	M1 M2	daN	365 295	540 450	800 670	820 780	990 950
Breakout power 750 mm in front of pivot		R	daN	560	850	960	1.010	1.430
Max. Lift height at attachment pivot		H	mm	2.000	2.290	2.435	2.590	2.800
Loading height		L	mm	1.845	2.130	2.275	2.425	2.630
Dump height		A	mm	1.340	1.510	1.655	1.805	2.020
Dump clearance		W	mm	220	250	250	300	500
Digging depth		S	mm	75	85	105	110	120
Boom pivot		B	mm	996	1.196	1.196	1.216	1.276
Rollback angle	lowered	X	° degree	43.0°	39.2°	38.8°	43.0°	45.1°
Dump angle raised	raised	Z	° degree	83.0°	78.7°	82.4°	71.2°	65.8°
Pump performance			l/min.	15	20	25	30	40
Raising time			sec.	2,5	2,7	3,4	3,3	3,2
Rollback time, attachment	lowered		sec.	1,4	1,5	1,1	1,3	1,1
Dump time, attachment	raised		sec.	2	2,1	1,6	2	1,8
Weight, loader boom w/o attachment			kg	165	205	230	270	290

Attention!

An OPG must be used for tractors with ROP (without cab). The front loader must not be used without an OPG!
See page 9.

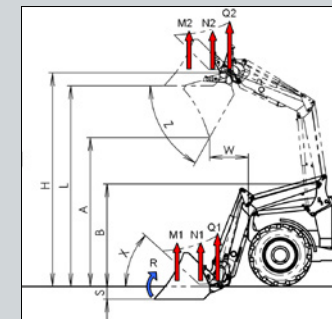

Values given are averages. Depending on tractor type, variations up and down will occur. The hydraulic pressure of the FC 150 = 140 bar, for all other FC front loaders 170 bar. Because of danger of rolling the tractor, front loader work can only be carried out with a suitable counter weight.



ALL BUCKETS IN FULL ACTION!

A TOUGH PERFORMER FOR YOUR PROFILE: THE PERFECT BUCKET FOR EVERY DEMAND, VERSATILE IN USE AND STRONG IN CONSTRUCTION:

- ✓ High level of robustness, low wear and low weight thanks to the use of high quality steel.
- ✓ Easy work even with sticky products – the conical shape, which opens up towards the cutting edge, makes this possible.
- ✓ The cutting edge can withstand the toughest stress – day after day, year after year.

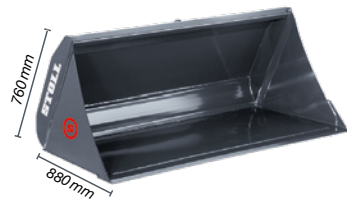

Cutting edge hardness
BRINELL 500

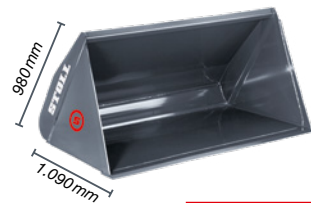

Cutting edge hardness
BRINELL 500

ROBUST U.
For universal, light to moderate use.

Order no.	Width in m	Volume heaped in m ³	Volume level heap in m ³	Cutting edge Brinell Schneidkante	Weight in kg		Price (excl. VAT)
3428170	1,15	0,47	0,41	110 x 16	130		825 €
3428180	1,30	0,51	0,44	110 x 16	132		840 €
3428190	1,50	0,60	0,52	150 x 16	161		905 €
3428200	1,70	0,68	0,59	150 x 16	176		935 €
3428210	1,90	0,76	0,66	150 x 16	211		1.015 €
3428220	2,05	0,82	0,71	150 x 16	225		1.195 €
3428230	2,20	0,89	0,77	150 x 16	269		1.370 €
3461720	2,40	0,94	0,82	150 x 20	310		1.515 €

ROBUST M.
Specifically for the loading of loose bulk materials with low weight.

Order no.	Width in m	Volume heaped in m ³	Volume level heap in m ³	Cutting edge Brinell Schneidkante	Weight in kg		Price (excl. VAT)
3428330	2,05	1,45	1,13	150 x 16	320		1.805 €
3429920	2,20	1,56	1,22	150 x 16	384		1.910 €
3429930	2,40	1,70	1,33	200 x 20	432		2.120 €
3429940	2,60	1,86	1,45	200 x 20	462		2.170 €

Gripping legends and digging marvels. Our STOLL buckets get to grips with power, hand in hand with our ProfiLine.

ROBUST S.

For working with heavy and sticky material, like wet earth or snow.



Cutting edge hardness
BRINELL 500

Order no.	Width in m	Volume heaped in m ³	Volume level heap in m ³	Cutting edge Brinell Schneidkante	Weight in kg		Price (excl. VAT)
3428260	1,50	0,60	0,52	150 x 16	172		1.155 €
3428270	1,70	0,68	0,59	150 x 16	190		1.250 €
3428280	1,90	0,74	0,64	150 x 20	242		1.375 €
3428290	2,05	0,81	0,70	150 x 20	258		1.525 €
3428300	2,20	0,87	0,76	150 x 20	308		1.785 €
3428310	2,40	0,94	0,82	200 x 20	351		1.960 €
3459310	2,60	1,01	0,88	200 x 20	376		2.445 €

ROBUST T.

With tines for earth moving and digging.



Cutting edge hardness
BRINELL 500

Order no.	Width in m	Volume heaped in m ³	Volume level heap in m ³	Cutting edge Brinell Schneidkante	Weight in kg	Tines	Price (excl. VAT)
3436990	1,50	0,60	0,52	150 x 16	177	5	1.315 €
3437000	1,70	0,68	0,59	150 x 16	190	6	1.440 €
3437010	1,90	0,74	0,64	150 x 20	242	6	1.590 €
3437020	2,05	0,81	0,70	150 x 20	258	7	1.935 €
3437030	2,20	0,87	0,76	150 x 20	308	7	2.040 €
3437040	2,40	0,94	0,82	200 x 20	351	8	2.200 €
3459300	2,60	1,01	0,88	200 x 20	376	8	2.630 €

4 IN 1 BUCKET.

Shovel, grab, level, lift – all with one shovel, all with ease!



NEW!

Order no.	Width in m	Height in m	Volume heaped in m ³	Volume level heap in m ³	Weight in kg		Price (excl. VAT)
3772430	1,70	0,81	0,43	0,37	332		2.730 €
3772440	1,90	0,81	0,48	0,48	358		2.905 €
3772450	2,05	0,78	0,52	0,45	377		3.080 €

3rd control circuit required

MULTI-PURPOSE BUCKET HD.

Suitable for all kinds of silage:
ideal for direct loading and transportation.

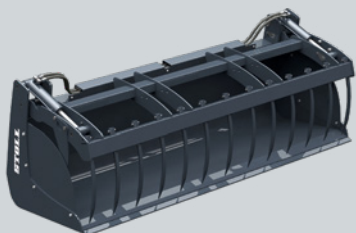

Order no.	Width in m	Volumen in m ³	Opening width in mm	Weight in kg			Price (excl. VAT)
3668340	2,05	0,85	1.320	443			4.015 €
3668350	2,20	0,92	1.320	472			4.635 €
3668360	2,50	1,00	1.320	512			5.070 €
Side plate (details per set)							
3659430	-	-	-	-			255 €
Lateral teeth (details per set)							
3659420	-	-	-	-			195 €

3rd control circuit required

BUCKET WITH GRAPPLE.

The universal implement for silage handling: thanks to the closed bottom, also wet and/or loose material can be handled.

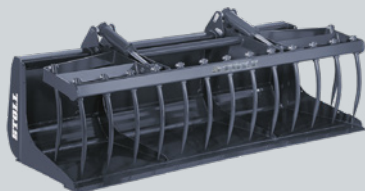

Order no.	Width in m	Volumen in m ³	Opening width in mm	Weight in kg			Price (excl. VAT)
3547610	1,50	0,59	1.290	292			2.925 €
3547620	1,70	0,67	1.290	314			3.095 €
3547630	2,05	0,82	1.290	373			3.440 €
3547650	2,20	0,88	1.290	423			3.650 €
Side plate optional (details per unit)							
3548350							170 €

3rd control circuit required

FORK WITH GRAPPLE.

Perfect to transport silage or manure.



Order no.	Width in m	Volume heaped in m ³	Tines bottom	Opening width in mm	Weight in kg		Price (excl. VAT)
3429090	1,30	0,54	7	1.300	226		2.730 €
3429100	1,50	0,63	8	1.300	249		2.960 €
3429110	1,70	0,71	9	1.300	268		3.170 €
3429120	2,05	0,87	11	1.300	304		3.540 €
3430650	2,40	1,02	13	1.300	355		3.830 €

3rd control circuit required



SILAGE CUTTERS PROFI-CUT.

For taking portions of silage;
the serrated edge ensures a straight cut.

Order no.	Width in m	Volumen in m ³	Depth in mm	Opening width in mm	Number of tines	Weight in kg	Price (excl. VAT)
3334760	1,28	0,87	790	856	10	500	4.545 €
2449320	1,52	1,05	790	856	13	530	4.990 €
3306680	1,88	1,28	790	856	16	730	6.795 €
Shove off device							
3521560							230 €
3rd control circuit required With width 1,88 two shove off devices required.							

MANURE FORK.

For handling manure.
The arrangement of the tines prevents load loss.



Order no.	Width in m	Opening width in mm	Number of tines	Weight in kg			Price (excl. VAT)
3364760	1,25	810	7	125			945 €
3364690	1,50	810	8	145			1.175 €
3364520	1,75	810	10	165			1.405 €
Lateral tine (details per set)							
3534780							135 €
3611820	2,00	810	11	243			1.895 €
3611830	2,00	1.100	11	264			2.115 €
3611930	2,25	1.100	12	288			2.820 €
3660460	2,50	1.100	14	318			3.025 €
Lateral tine (details per set)							
3534780							155 €
Loading grill (for forks from 2.00 m working width)							
3599680	2,00			40			290 €

Even wheel loaders are quaking in their boots. Pros for the ProfiLine.



BUCKET WITH GRAB.

Suitable for all kinds of silage:
ideal for direct loading and transportation.

Order no.	Width in m	Opening width in mm	Volumen in m ³	Weight in kg	Price (excl. VAT) €
3687650 *	1,60	1.480	0,88	512	4.030 €
3687660	1,80	1.480	1,00	549	4.320 €
3687670	2,00	1.480	1,10	601	4.610 €
3687680	2,20	1.480	1,21	641	4.780 €
3687690	2,50	1.480	1,38	753	6.225 €
Corn tine optional (details per set)					
3635370					180 €

3rd control circuit required | * See page 47.

DISPOSER BUCKET.

Multi-functional implement, especially for bulky goods.



Order no.	Width in m	Opening width in mm	Volumen in m ³	Weight in kg	Price (excl. VAT) €
3591550	1,80	1.480	1,00	557	3.590 €
3632970	2,00	1.480	1,10	605	3.840 €
3591560	2,20	1.480	1,21	636	3.995 €
3602920	2,50	1.480	1,38	762	5.185 €
Side plate wahlweise (details per set)					
3660080					410 €

3rd control circuit required

NEW!



GRAPPLE BUCKET.

Multifunctional implement, always with one handle.

Order no.	Width in m	Opening width in mm	Volumen in m ³	Weight in kg	Price (excl. VAT) €
3789180	2,20	1.460	0,87	673	6.350 €
3789190	2,40	1.690	0,94	714	7.000 €
3789200	2,60	1.810	1,01	762	7.350 €

3rd control circuit required



TO THE BALES, GET SET, GO!

EVERY SUMMER IS HIGH SEASON FOR BALES – PREPARE YOURSELVES IN GOOD TIME: WITH STOLL BALE TOOLS.

Whether round or square bales, with foil or without: At STOLL you can always find the right tools.

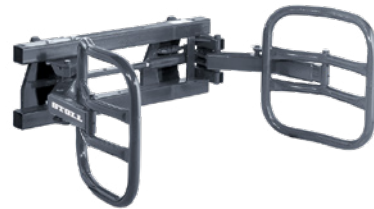

WRAPPED BALE HANDLER H.

Perfectly suitable for foil wrapped round bales: there are no sharp edges that can damage the foil.

Order no.	Weight in kg						Price (excl. VAT)
2364610	225						2.535 €

For round bales Ø from 1,00 m to 1,80 m / for square bales Ø 1,60 m |
3rd control circuit required

WRAPPED BALE HANDLER-PRO H.

For the safe handling of round and square wrapped bales.

Order no.	Weight in kg						Price (excl. VAT)
3395020	305						3.165 €

Largest / smallest opening: 2,05 m / 0,65 m | Effective depth: 1,20 m | Transport width: 1,35 m | for square and round wrapped bales
3rd control circuit required

BALE CARRIER REAR.

For the transport of round and wrapped bales in the rear.

Order no.	Weight in kg						Price (excl. VAT)
3336750	115						805 €

Tractor rear three-point linkage or device triangle | Gripping area from 0,94 m to 1,34 m in 5 cm intervals / Lift arm boom length 1,28 m

BALE CARRIER REAR H.

Ideal for transporting round bales.

Order no.	Weight in kg						Price (excl. VAT)
3380410	105						850 €

For round bales | Gripping area from 0,82 m to 1,22 m / Beam length 1,28 m / Pipe diameter 0,16 m

Bale handlers by STOLL are the perfect choice for every size of bale.



ROLL-TYPE BALE FORK.

Fits all bale types.

Order no.	Weight in kg						Price (excl. VAT)
3573240	245						2.195 €

For round and square wrapped bales / Gripping range from 0,60 m to 1,85 m | **3rd control circuit required**



MAXI BALE CLAW H.

Simultaneously grab, lift and load up to two bales.

Order no.	Weight in kg						Price (excl. VAT)
2449950	150						2.405 €

For round and square bales | **3rd control circuit required**



BALE FORK LIFT H.

The built-in lifting device brings a height gain of up to 1,40 m.

Order no.	Weight in kg						Price (excl. VAT)
1339660	260						2.695 €

For round and square bales / lifting height gain of 1,40 m to the normal height | **3rd control circuit required**



BIG BALE FORK.

For safe transport of multiple stacked bales.

Order no.	Tine in mm	Weight in kg	Payload in kg				Price (excl. VAT)
3611920	1.200 foldable	147	1.000				1.260 €

For round and square bales. For safe empty driving on public roads, the bale tines can be folded upwards.



BIG BALE FORK FOLDING TINES.

Bale fork with center tines.

Order no.	Tine in mm	Weight in kg	Payload in kg				Price (excl. VAT)
3802030	1.113 foldable	290	1000				1.500 €

For round and square bales. For safe empty driving on public roads, the bale tines can be folded upwards.

Anyone can pile it on thick, but only a few are true to their word. Our pallet and bale forks are real experts in their field.

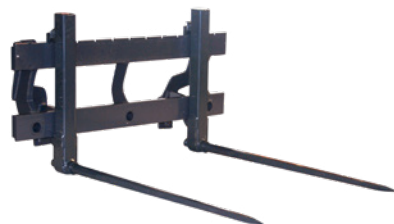

NEW!

BALE SPIKE H.

Variable tine placing
– so the spike suits all bales.

Order no.	Lifting capacity in kg	Tine in mm	Weight in kg				Price (excl. VAT)
3378240	-	1x 800 / 1x 1200	92				715 €
3411860	-	2 x 1200	95				725 €
Frame							
3385190	1.000	-	76				515 €
Heavy duty tines (per unit)							
1330130	-	1200	9				105 €
Heavy duty tines (per unit)							
0476240	-	800	5				95 €

For round and square bales | Additional tines can be retrofitted

BIG BALE FORK HS.

The distance between the tines can be easily changed.
Pallet fork tines can also be mounted onto these frames.

Order no.	Tine in mm	Weight in kg					Price (excl. VAT)
3684190	1200	137					1290 €
3684200	1200 foldable	143					1690 €
Frame HS							
3654340	-	110					660 €
Frame HS (details per unit)							
2400050	1200	20					315 €
3331520	1200 foldable	23					515 €

For round and square bales

PALLET FORK HD + SKID STEER.

Selectable for Euro or Skid Steer mounting.

Order no.	Lifting capacity in kg	Tine in mm	Weight in kg	Width in mm	Connection		Price (excl. VAT)
3779120	1.600	1200	174	1.250	Skid Steer/Euro		1.370 €
3779130	1.600	1.000	166	1.250	Skid Steer/Euro		1.230 €
Frame HD							
3779140	2.500	-	102	1.250	-		750 €
Pallet tine HD (details per unit)							
3570720	1.600	1200	36	-	-		310 €
3570710	1.600	1.000	32	-	-		240 €

EVERY- THING ALRIGHT.

**LIFTING, LOADING,
STACKING – WITH STOLL
PALLET FORKS FOR
YOUR PROFILINE YOU
WILL ALWAYS WORK
PRECISELY:**

- ✔ These pallet forks are particularly sturdy because STOLL places a high value on robust construction and top-quality materials.
- ✔ You can position the tines exactly how you need them for your work. The tines can be moved by hand.
- ✔ The largest pallet fork lifts up to 3.5 t and belongs in the top class of front loader tools.

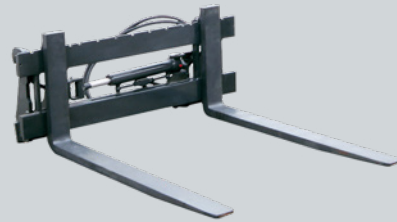
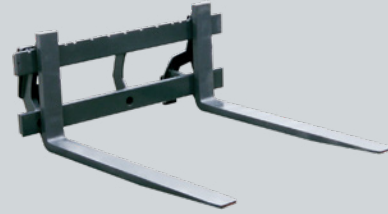

PALLET FORK HD.

The forks can be moved freely – the driver can also mount bale tines to the frame.

Order no.	Lifting capacity in kg	Tine in mm	Weight in kg	Width in mm	Connection	Price (excl. VAT)
3646850	2.500	1.200	196	1.250	ISO 2328	1.310 €
3654360	1.600	1.200	166	1.250	ISO 2328	1.210 €
3654370	1.600	1.000	158	1.250	ISO 2328	1.080 €
Frame HD						
3654340	2.500		94	1.250	ISO 2328	660 €
Pallet tine HD (details per unit)						
3570730	1.250	1.200	51		ISO 2A	325 €
3570720	800	1.200	36		ISO 2A	275 €
3570710	800	1.000	32		ISO 2A	210 €

Frame includes 3 bushes for bale tines

PALLET FORK HD WITH SIDE SHIFT.

The forks can be moved hydraulically as required.

Order no.	Lifting capacity in kg	Tine in mm	Weight in kg	Width in mm	Connection	Price (excl. VAT)
3614380	2.000	1.200	257	1.250	ISO 2328	3.050 €
Frame HD						
3666450	2.000		155	1.250	ISO 2328	2.400 €
Pallet tine HD (per unit)						
3570730	1.250	1.200	51		ISO 2A	325 €

Side shift +/- 145 mm | 3rd control circuit required

PALLET FORK HS 1500.

In addition to the pallet fork tines, as many as four bale tines can be mounted on the frame.

Order no.	Lifting capacity in kg	Tine in mm	Weight in kg	Width in mm	Connection	Price (excl. VAT)
3430830	1.600	1.000	185	1.500	ISO 2328	1.405 €
3434900	1.600	1.200	200	1.500	ISO 2328	1.535 €
Frame HS 1500						
3434840	1.600		115	1.500	ISO 2328	985 €
Pallet tine HS (details per unit)						
3570710	800	1.000	43		ISO 2A	210 €
3570720	800	1.200	66		ISO 2A	275 €

LIFTING- AIDS.

HEAVY LIFTING – LIGHT WORK.

The declared goal of our STOLL engineers is developing tools to make farming more efficient. With reduced manpower and robust technology you can manage your daily tasks much more easily. Your ProfiLine will also feel the benefit.



Your tasks become effortless and efficient. STOLL ProfiLine loader is built to handle heavy lifting while making your workday significantly lighter.

BIGBAG-LIFT.

Especially developed for bulk bags with one or two loops. The implement raises the load above the implement rotation point – so the view is guaranteed to be free.

Order no.	Payload in kg	Weight in kg	Lifting height above implement pivot point in mm				Price (excl. VAT)
3602900	1.000	115	1.500				1.260 €

For bulk bags up to 1,000 kg



BAG-LIFT H.

Perfect for bulk bags with four loops.

Order no.	Payload in kg	Weight in kg	Lifting height above implement pivot point in mm				Price (excl. VAT)
2357100	1.000	180	500				1.310 €

For bulk bags up to 1,000 kg



LOADING HOOK.

For good balance during transport: the load is centered near the front axle.

Order no.	Payload in kg	Weight in kg					Price (excl. VAT)
2309670	2.000	16					380 €

The hook is swivel mounted

IDEAL FOR TIMBER AND FORESTRY.

WOOD MAKING – STOLL FORESTRY IMPLEMENTS ENSURE EFFECTIVE WORK.

The log fork H and the log fork are specialists in forestry.



LOG FORK H WITH HYDRAULIC TOP-LOADING GRIP.

Gripping of logs with the top loading grip – so nothing is lost.

Order no.	Grip opening in m (clear width)	Weight in kg					Price (excl. VAT)
3390260	1,04	235					2.770 €
3rd control circuit required							



LOG FORK H.

For the transport and bunching of logs.

Order no.	Weight in kg						Price (excl. VAT)
1317750	150						1.410 €



TOP LOADING GRIP.

The ideal complement to the pallet fork, to retrieve or load logs.

Order no.	Opening width in mm	Weight in kg					Price (excl. VAT)
3548990	1.385	79					1.030 €
For pallet fork HD and HS 1500 (must be ordered separately) - 3rd control circuit required							



THE SMART EXTRA.



SAFETY GRILL.

So nothing slips: secures the load to the rear.

Order no.	Weight in kg						Price (excl. VAT)
3570550	23						265 €
For big bale fork HS and pallet fork HD – Does not fit for 1.500 mm frames							



14 DEG ADAPTER.

Thanks to the improved tilt angle everything stays inside the bucket.

Order no.	Weight in kg						Price (excl. VAT)
3522000	12						215 €
To improve the tipping angle (crowd) (set: 2 brackets incl. screws) – fits only for buckets and manure forks							



THREE-POINT-LINKAGE-ADAPTER.

For the rear-mounted hook implements.

Order no.	Weight in kg						Price (excl. VAT)
3386990	60						445 €
For hook implements in 3 point rear mounting, lifting capacity 1,5 t at the coupling point of the lower linkage							



CONVERSION KIT TO HOOK IMPLEMENTS.

For the conversion of hook implements to Euro standard.

Order no.	Weight in kg			Price (excl. VAT)
1334090	19			275 €
1 Conversion Kit (left + right)				



HOOKS AND EYES.

The individual set for conversion to hook implements.

Order no.	Weight in kg			Price (excl. VAT)
3320080	-			130 €
Loose set: 2 hooks, 2 eyes				



IMPLEMENT STAND.

Everything tidy: the ideal storage space for up to four implements.

Order no.	Width in m	Height in m	Weight in kg	Price (excl. VAT)
3523120	1,22	2,40	150	1.235 €
Delivery without implements.				

ADAPTER / QUICK-CHANGE FRAME.

Order no.	Weight in kg			Price (excl. VAT)
3664360	70			790 €
Adapter Euro to Tenias				
3551060	44			735 €
Adapter Euro to Fauchaux				
3733790	78			450 €
MX tool adapter for Euro quick-change frame mechanical locking device				
Option:				
Skid Steer quick-change frame				
Euro quick-change frame				
Euro + Alö quick-change frame				
Euro +SMS quick-change frame				

STOLL thinks globally and liberally. That's why, in our range, you will also find smart special solutions for **ProfiLine**, if that's what your life requires. **STOLL** supports you all the time.

EVERY TOOL FITS – EVEN THOSE BY OTHER MANUFACTURERS.

- ✓ Our customers can attach all tools with a Euro attachment to STOLL front loaders in the ProfiLine series and the Solid.
- ✓ Even coupling systems from other manufacturers fit with these front loaders – with our combi-change frame.



Tenias adapter



Euro



MX tool adapter for Euro quick-change frame



Euro + Alö



Skid Steer



Euro + SMS

CLASSIC ALL-ROUNDER.

**THE SOLID STANDS
OUT FOR ITS FLEXIBLE
USAGE POSSIBILITIES:
EVERYTHING IN THE USUAL
TOP STOLL QUALITY WITH
AN EXCEPTIONAL PRICE/
PERFORMANCE RATIO.
HERE YOU WILL FIND THE
EXTENSIVE TOOL RANGE
THAT FITS THE SOLID.**



- ✓ Easy to handle
- ✓ Flexible implementation
- ✓ Long working life

NEW!



TOP GRIPPER PALLET FORK GLOBAL.

The ideal complement to the pallet fork, to retrieve or load logs.

Order no.	Opening in mm	Weight in kg					Price (excl. VAT)
3793930	900	45					270 €

PALLET FORK.

Pallet loading made easy. Thanks to its sturdy construction, you can pick up to 1.000 kg at a time with the pallet fork. Adjust the spacing of the pallet tines to suit your needs.

Order no.	Lifting capacity in kg	Tine in mm	Weight in kg	Width in mm	Connection		Price (excl. VAT)
Pallet fork							
3567980	1.000	1.000	113	1.200	ISO 2328		840 €
Frame							
3567990	1.000	-	59	1.200	ISO 2328		440 €
Pallet tine (per unit)							
3570700	500	1.000	27		ISO 1A		200 €

SOLID BUCKET U SKID STEER.

For all loading work.

Order no.	Width in m	Height in mm	Depth in mm	Volume heaped in m³	Volume level heap in m³	Weight in kg	Price (excl. VAT)
3550530	1,40	695	730	0,45	0,36	89	820 €
3550540	1,60	695	730	0,52	0,41	100	860 €
3550550	1,85	695	730	0,61	0,48	125	920 €
3550560	2,10	695	730	0,7	0,55	166	1.080 €

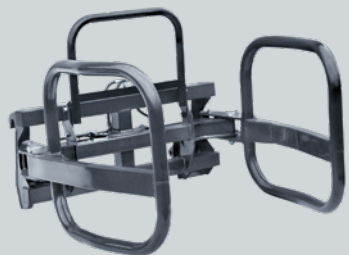

WRAPPED BALE HANDLER.

So your wrapped bales remain undamaged. The wrapped bale tongs have no sharp edges and have been developed specifically for the transportation and loading of wrapped bales.

Order no.	Opening width in mm (largest/smallest)	Weight in kg				Price (excl. VAT)
3714810	1.400/800	114				2.215 €
For round bales ø from 0,80 m to 1,40 m, 3rd control circuit required						

BALE SPIKE.

A spike for all bales. Transport round and square bales easily and safely with the bale spike. The tines can be placed in four positions in the frame, depending on the application.



Order no.	Lifting capacity in kg	Tine in mm	Weight in kg			Price (excl. VAT)
3611810	700	2 x 800	68			600 €
3608420	700	2 x 1.200	76			620 €
Frame						
3608430	-	-	58			410 €
Tine						
0476240	-	800	5			95 €
Tine						
1330130	-	1.200	9			105 €
The bale spike has been developed for the handling of round and square bales.						

SOLID BUCKET U EURO.

Ideal for light to moderate use. Your loose bulk material can also be easily loaded.

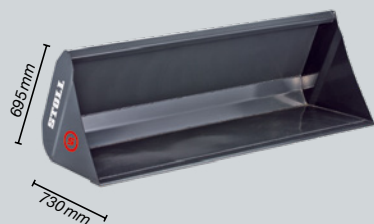

Order no.	Width in m	Volume heaped in m ³	Volume level heap in m ³	Weight in kg		Price (excl. VAT)
3774650	1,20	0,39	0,31	88		635 €
3550490	1,40	0,45	0,36	99		655 €
3550500	1,60	0,52	0,41	109		730 €
3550510	1,85	0,61	0,48	131		825 €
3550520	2,10	0,70	0,55	171		965 €

The superheroes of tools. Steeled for every challenge, these tools stand their ground. Reliable and powerful.





COMPACT LOADERS.

**IDEAL FOR ALL TASKS - THE EXTENSIVE
COMPACTLINE TOOL RANGE REMAIN
IMPRESSIVE IN TIGHT SITUATIONS.**

- ✓ Shovelling, grabbing or loading – STOLL tools offer the right solution for all tasks. Round about the house and farmyard, forest, garden and landscaping!
- ✓ For the driver to have unobstructed sight of the working zone, all tools have a Skid Steer attachment.
- ✓ Even the small ones have great power: the light and compact construction of these tools fits perfectly with the CompactLine.

The sandpit's over. Our CompactLine buckets load, shovel and grab like the big boys.

NEW!

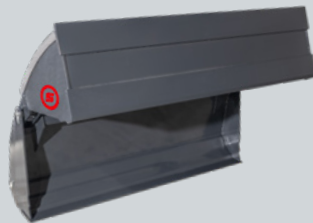

4 IN 1 BUCKET SKID STEER.

Shovel, grab, level, lift – all with one shovel, all with ease!

Order no.	Width in m	Height in mm	Volume heaped in m ³	Volume level heap in m ³	Opening width in m	Weight in kg	Price (excl. VAT)
3771700	1,40	590	0,19	0,16	680	152	1.750 €
3771710	1,60	590	0,21	0,18	680	167	1.900 €

NEW!



FC BUCKET EURO.

For all loading work.

Order no.	Width in m	Height in mm	Depth in mm	Volume level heap in m ³	Volume heaped in m ³	Weight in kg	Price (excl. VAT)
3799110	1,25	565	655	0,22	0,25	73	675 €
3799100	1,25*	565	535	0,15	0,17	62	700 €
3799120	1,40	565	655	0,25	0,28	79	875 €
3799130	1,60	565	655	0,28	0,32	87	985 €
3799140	1,75	565	655	0,31	0,35	93	1.095 €

* for CompactLine FC 150 P

NEW!

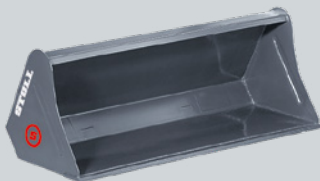

FC BUCKET SKID.

For all loading work.

Order no.	Width in m	Height in mm	Depth in mm	Volume level heap in m ³	Volume heaped in m ³	Weight in kg	Price (excl. VAT)
3769440	1,25	565	655	0,22	0,25	70	660 €
3769430	1,25*	565	535	0,15	0,17	58	685 €
3769450	1,40	565	655	0,25	0,28	76	855 €
3769460	1,60	565	655	0,28	0,32	84	965 €
3769470	1,75	565	655	0,31	0,35	90	1.070 €

* for CompactLine FC 150 P

Whether it's bale-handling, pallet loading, log moving or other tasks, compact STOLL tools are all-rounders. They work daily to stand up to tricky, highly diverse tasks.

BUCKET WITH GRAPPLE.

The universal gripper, because thanks to the closed bottom, wet and/or loose material can also be transported.



Order no.	Width in m	Height in m	Depth in m	Opening in mm	Weight in kg		Price (excl. VAT)
3535300	1,20	0,67	0,60	950	115		1.815 €
3535310	1,45	0,67	0,60	950	130		1.955 €

3rd control circuit required

FORK WITH GRAPPLE.

Ideal to retrieve and load manure, compost, shrubs and silage.



Order no.	Width in m	Height in m	Depth in m	Opening width in mm	Weight in kg		Price (excl. VAT)
3535320	1,20	0,69	0,61	950	120		2.115 €
3535330	1,45	0,69	0,61	950	135		2.265 €

3rd control circuit required

GRIP FORK.

A must in forestry and landscape maintenance:
With the strong tines it grabs bulky tree trunks and branches.

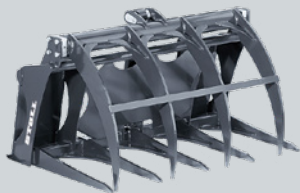

Order no.	Width in m	Opening width in mm	Weight in kg				Price (excl. VAT)
3508220	1,15	870	130				1.625 €

3rd control circuit required

MANURE FORK.

For loading of farmyard manure and compost.



Order no.	Width in m	Height in m	Depth in m	Weight in kg			Price (excl. VAT)
3509620	1,21	0,56	0,67	68			935 €
3535290	1,45	0,56	0,67	79			1.050 €



BALE TINE.

Compact bale handling in narrow courtyards or stables.

Order no.	Tine in mm	Weight in kg	Lifting capacity in kg				Price (excl. VAT)
3486330	800	60	1.000				775 €
Frame							
3486100	-	36	-				405 €
Bale tine (per unit)							
3486320	800	12	500				185 €
Optional pallet tine (per unit)							
3486290	800	12	500				185 €



PALLET FORK.

The classic to load pallets.

Order no.	Lifting capacity in kg	Tine in mm	Weight in kg	Top loading grip compatibility			Price (excl. VAT)
3486070	1.000	800	60	3520780 (p. 43)			880 €
3733280	1.000	1.000	113	3548990 (p. 35)			985 €
Frame							
3486100	-	-	36	3520780 (p. 43)			460 €
3733290	-	-	59	3548990 (p. 35)			525 €
Bale tine (per unit)							
3486290	500	800	12	3520780 (p. 43)			210 €
3570700	500	1.000	27	3548990 (p. 35)			230 €
Optional pallet tine (per unit)							
3486320	500	800	12	3520780 (p. 43)			210 €



TOP LOADING GRIP.

The ideal complement to the pallet fork, to retrieve or load logs.

Order no.	Opening width in mm	Weight in kg					Price (excl. VAT)
3520780	870	40					645 €

For CompactLine pallet fork (has to be ordered separately) | **3rd control circuit required**



LOG GRAPPLE.

Grab and load logs individually.

Order no.	Width in m	Opening width in mm (max.)	Weight in kg				Price (excl. VAT)
3556810	0,29	750	115				1.975 €
Log grapple without boom (can be combined with boom of shovel)							
3611140							1.470 €
Rotator optional							
3601520							1.745 €
3rd control circuit required							



SHOVEL.

Dig narrow, deep trenches – up to 1,16 m below ground level.

Order no.	Width in m	Working depth below ground (m)	Swivel angle	Weight in kg			Price (excl. VAT)
3557480	0,30	1,16	118°	105			1.315 €
Digging shovel without boom (can be combined with arm of log grapple)							
3611160							825 €
Boom Ditching shovel							
3599580	0,80						750 €
3rd control circuit required							



THREE-POINT-ADAPTER.

For the rear mounting of implements for CompactLine onto tractors.

Order no.	Payload in kg	Weight in kg					Price (excl. VAT)
3601100	500	38					610 €

Looking for an implement to compliment your other brand of loader? We are here to help. That's exactly why we have constructed adapter frames for the CompactLine that allow you to complete your tractor and a previously owned loader from a different brand with our tools.

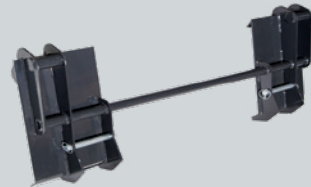

ATTACHMENT FRAME EURO-SKID.

Mount implements with Euro-connection onto a Skid Steer attachment frame.

Order no.	Weight in kg				Price (excl. VAT)
3547310	23,5				485 €

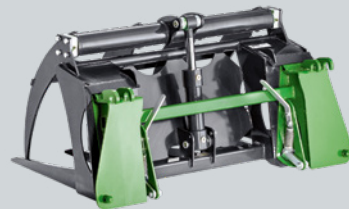

IMPLEMENT ADAPTER FOR JOHN DEERE COMPACT FRONT LOADER.

Real STOLL quality on John Deere compact loaders.

Order no.	Weight in kg				Price (excl. VAT)
3571680	30				525 €

RECOMMENDED TOOL WIDTH.

Width	FZ 36-20 FZ 36-24 FS 36-24	FZ 39-23*	FZ 39-27* FZ 39-31* FS 39-27 FS 39-31 FS IB+ 39-35	FZ 41-25*	FZ 41-29*	FZ 41-33* FS 41-33 FS IB+ 41-37	FZ 43-27* FZ 43-30* FZ 43-34* FS 43-34 FS 43-38*	FZ 46-26* FZ 46-29* FZ 46-33* FZ 46-37* FS IB+ 46-37	FZ 48-33* FZ 48-37* FZ 48-42*	Solid 28-14 P	Solid 30-16 P/H	Solid 35-18 P/H	Solid 38-20 P/H	Solid 40-22 P/H
Robust U - Universal bucket														
1,15 m	•									•	•	•		
1,30 m	•	•	•							•	•	•	•	
1,50 m	•	•	•								•	•	•	
1,70 m		•	•	•	•	•							•	•
1,90 m		•	•	•	•	•							•	•
2,05 m				•	•	•								•
2,20 m				•	•	•	•							
2,40 m						•	•	•	•					
Robust M - Maxi-bulk buckets														
2,05 m				•	•	•	•	•	•					
2,20 m				•	•	•	•	•	•					
2,40 m						•	•	•	•					
2,60 m							•	•	•					
Robust S / T - heavy duty series														
1,50 m		•	•	•	•	•							•	•
1,70 m		•	•	•	•	•	•	•	•				•	•
1,90 m				•	•	•	•	•	•					•
2,05 m				•	•	•	•	•	•					
2,20 m				•	•	•	•	•	•					
2,40 m						•	•	•	•					
2,60 m							•	•	•					

* The values correspond to the same marked model from the ProfiLine ISOBUSConnected series marked IB+.

Width	FZ 36-20 FZ 36-24 FS 36-24	FZ 39-23*	FZ 39-27* FZ 39-31* FS 39-27 FS 39-31 FS IB+ 39-35	FZ 41-25*	FZ 41-29*	FZ 41-33* FS 41-33 FS IB+ 41-37	FZ 43-27* FZ 43-30* FZ 43-34* FS 43-34 FS 43-38*	FZ 46-26* FZ 46-29* FZ 46-33* FZ 46-37* FS IB+ 46-37	FZ 48-33* FZ 48-37* FZ 48-42*	Solid 28-14 P	Solid 30-16 P/H	Solid 35-18 P/H	Solid 38-20 P/H	Solid 40-22 P/H
Manure Forks														
1,25 m / 7 tines 0,81m lg.	•	•	•	•	•						•	•	•	
1,50 m / 8 tines 0,81m lg.		•	•	•	•	•							•	•
1,75 m / 8 tines 0,81m lg.		•	•	•	•	•	•	•	•					•
2,00 m / 11 tines 0,81m lg.					•	•	•	•	•					
2,00 m / 11 tines 1,1m lg.							•	•	•					
2,25 m / 12 tines 1,1m lg.							•	•	•					
2,50 m / 14 tines 1,1m lg.								•	•					
Bucket with grab / Disposer shovel														
1,60 m*	•	•	•	•	•	•	•	•	•					
1,80 m		•	•	•	•	•	•	•	•					
2,00 m			•	•	•	•	•	•	•					
2,20 m				•	•	•	•	•	•					
2,50 m								•	•					
Multi-purpose bucket HD														
2,05 m		•	•	•	•	•	•	•	•				•	•
2,20 m				•	•	•	•	•	•					
2,50 m						•	•	•	•					
Bucket with grapple														
1,50 m	•	•	•								•	•	•	
1,70 m		•	•	•	•	•						•	•	
2,05 m		•	•	•	•	•	•						•	
2,20 m				•	•	•	•							

* Bucket with grab / Disposer shovel 1,60 m: Does not fit on broad beams

* The values correspond to the same marked model from the ProfLine ISOBUSConnected series marked IB+.

OUR COMPETENT TEAM WORLDWIDE.

GERMANY

Sales Manager for Germany, Austria, Switzerland+L

Markus Jankowski

Phone: +49 (0) 5344 20 126
Mobile: +49 (0) 171 566 02 51
E-mail: mj@stoll-germany.com

Oberbayern, Schwaben/Allgäu, Mittelfranken, Tübingen

Peter August

Mobile: +49 (0) 171 566 0254
E-mail: pau@stoll-germany.com

Oberfranken, Unterfranken, Oberpfalz, Niederbayern

Jens Bartenstein

Mobile: +49 (0) 170 638 56 00
E-mail: jba@stoll-germany.com

Baden-Württemberg, Schweiz

Michael Bosch

Phone: +49 (0) 171 566 02 31
E-mail: mbo@stoll-germany.com

Sachsen, Südbrandenburg, Ost-Süd-Sachsen-Anhalt,
Ostthüringen

Markus Burk

Phone: +49 (0) 35875 67 504
Mobile: +49 (0) 171 566 94 15
E-mail: mb@stoll-germany.com

Niedersachsen, Westmecklenburg, Nördliches Sachsen-Anhalt,
Schleswig-Holstein

Adrian Knop

Mobile: +49 (0) 171 / 5 66 02 18
E-mail: ako@stoll-germany.com

Hessen, Rheinland-Pfalz, Nordrhein-Westfalen, Saarland,
Luxemburg

Martin Schulze

Mobile: +49 (0) 171 566 02 45
E-mail: msh@stoll-germany.com

FRANCE

Regional Representative and Inspecteur commercial -
South France

Lionel Dalmont

Phone: +33 6 88 15 44 03
E-mail: ld@stoll-france.fr

Regional Representative and Inspecteur commercial -
East France

Yann Charles

Phone: +33 6 85 71 31 01
E-mail: yc@stoll-france.fr

Regional Representative and Inspecteur commercial -
Western France

Julien Langlois

Phone: +33 6 47 66 63 31
E-mail: jl@stoll-france.fr

Regional Representative and Inspecteur commercial -
Central and Western France

Florent Texier

Phone: +33 6 45 16 52 81
E-mail: ft@stoll-france.fr

BELGIUM , NETHERLANDS

Sales organization Netherlands and Belgium, Area Sales
Manager

G. A. Stoevelaar

Phone: +31 523 270851
E-mail: gst@stoll-germany.com

POLAND

Area Sales Manager

Karol Rajkowski

Mobile: +48 667 017 379
E-mail: kra@stoll-germany.com

AUSTRIA

Area Sales Manager

Alexander Schätzl

Mobile: +43(664)4625360
E-mail: asc@stoll-germany.com

NORTH EUROPE

Area Sales Manager

Peter Korning Ove

Phone: +45 40 17 27 39
E-mail: po@stoll-germany.com

SOUTH EAST EUROPE

Area Sales Manager South East Europe

Petko Petrov

Mobile: +49 171 5660255
E-mail: pp@stoll-loaders.com

EAST EUROPE

Area Sales Manager

Serhiy Hryn

Phone: +49 5344 20 122
Mobile: +49 170 638 56 04
E-mail: shr@stoll-germany.com

USA , CANADA

STOLL AMERICA LLC.

Thomas Neil

Mobile: (604) 340-4730
E-mail: thomas.neal@stoll-loaders.com

ASIA, AFRICA

Area Sales Manager Asia / South East Asia

Torben Meyer

Phone: +49 (0) 171 227 13 91
E-mail: tm@stoll-germany.com

INTERNATIONAL

International Sales Manager

Torben Meyer

Mobile: +49 (0) 171 227 13 91
E-mail: tm@stoll-germany.com



GENERAL.

TERMS OF PAYMENT:

All deliveries are always made in accordance with our terms and conditions of sale and delivery. The prices stated are intended for trade and commerce. The price information and technical specifications are non-binding. It is possible that both prices and technical specifications have changed in the meantime or that other prices or technical specifications apply in individual cases due to special circumstances. To obtain a binding offer, please contact us.

With the publication of this price list, all previous prices lose their validity. Non-binding prices in net ex works excluding packaging.

Recommended retail price in €.

Subject to change without notice. Illustrations partly with optional equipment. Front loaders must always be parked with a suitable tool. This has been omitted from some illustrations for reasons of presentation. The STOLL accessories and the components offered are intended exclusively for the purpose of intended operation with STOLL front loaders.





Wilhelm STOLL Maschinenfabrik GmbH
Bahnhofstr. 21 | 38268 Lengede
Telefon: +49 (0) 53 44 / 20-222
E-mail: info@stoll-germany.com



www.stoll-loaders.com

D-Stoll-Pricelist-2025-v03-20250224-P1619-EN-3807830